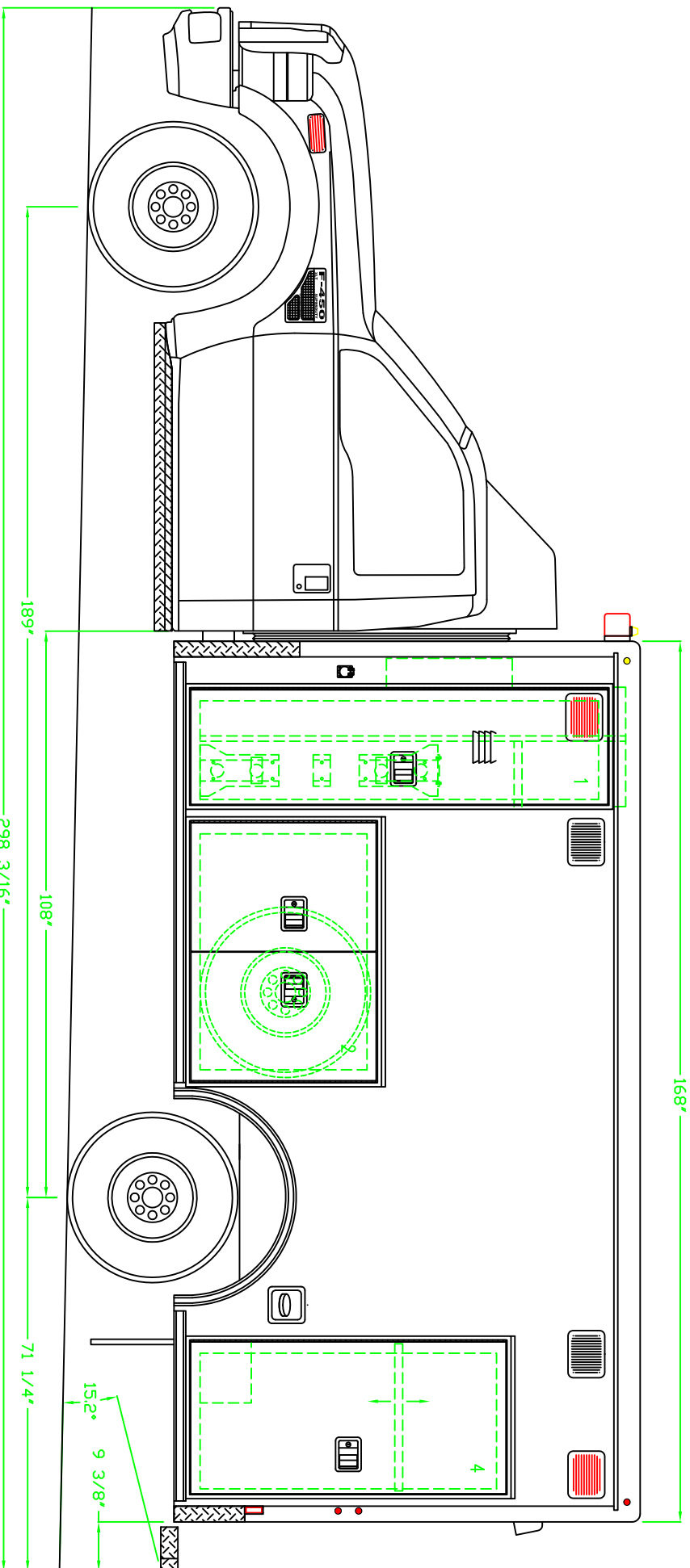

# 70" HEADROOM, 46 INCH AISLE F-450 ULTRAMEDIC WALK-THROUGH

DEALER SIGNATURE

DOOR NO.	INTERIOR DIMENSIONS	NOTES	NOTES:		
	HEIGHT	WIDTH	DEPTH		
1	81.50"	23.25"	21.00"	FIXED DIVDER & SHELF, DOOR LOUVERS	DETAILS ARE CONCEPTUAL ONLY. LAYOUT AND ALL DIMENSIONS ARE APPROXIMATE AND SUBJECT TO MODIFICATION BY DESIGN ENGINEERING.
2	34.00"	50.00"	21.00"	SPARE TIRE STORAGE	
4	58.50"	29.50"	21.00"	(1) ADJ. SHELF	

**Road Rescue, Inc.** 2914 SPARTAN PLACE  
P.O. BOX 1178  
MARION, SC 29571  
www.roadrescue.com PHONE 843-676-2900 FAX 843-676-2997

**STREETSIDE EXTERIOR DETAIL**

DATE: 9/1/07 REVISION 1 REVISION 2 REVISION 3 SCALE: NONE SHEET 1 OF 9

BID NUMBER: **BASE**

NOTE: THIS DRAWING IS SUBJECT TO CHANGE PENDING ROAD RESCUE, INC. PRODUCTION ENGINEERING APPROVAL. © ROAD RESCUE, INC. ALL RIGHTS RESERVED.

# 70" HEADROOM, 46 INCH AISLE F-450 ULTRAMEDIC WALK-THROUGH

DEALER SIGNATURE

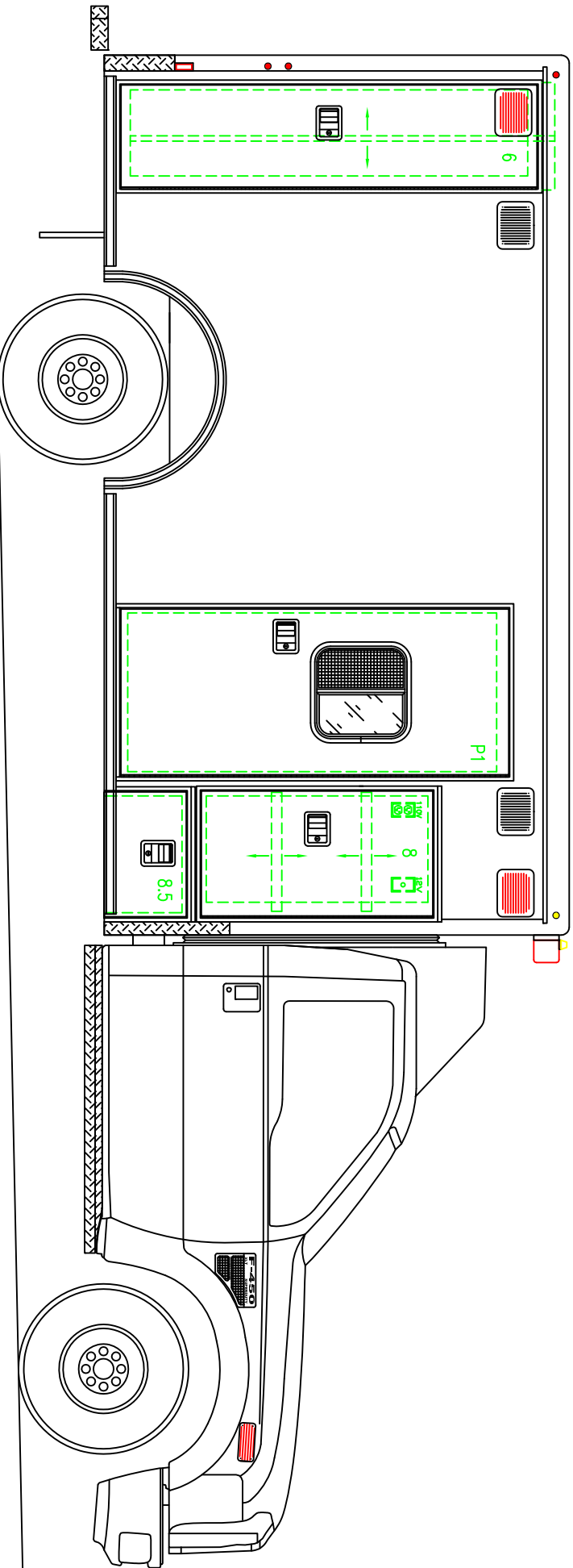

DOOR NO.	INTERIOR DIMENSIONS			NOTES	DOOR NO.	DOOR DIMENSIONS			MISC. NOTES
	HEIGHT	WIDTH	DEPTH			HEIGHT	WIDTH		
6	81.50"	21.50"	21.00"	(1) ADJ. DIVIDER	8	44.00"	24.00"		RIGHT STACK/ALS ACCESS
8.5	16.00"	24.00"	21.00"	BATTERY DRAWER	P1	74.50"	32.00"		SLIDING TINTED WINDOW 18" X 18"

DETAILS ARE CONCEPTUAL ONLY.  
LAYOUT AND ALL DIMENSIONS ARE APPROXIMATE AND SUBJECT TO MODIFICATION BY DESIGN ENGINEERING.

**Road Rescue, Inc.** 2914 SPARTAN PLACE  
P.O. BOX 1178  
MARION, SC 29571  
www.roadrescue.com PHONE 843-676-2900 FAX 843-676-2997

**CURBSIDE EXTERIOR DETAIL**

DRAWN BY: DATE: 9/1/07 REVISION 1 REVISION 2 REVISION 3 SCALE: NONE SHEET 2 OF 9

BID NUMBER: **BASE**

NOTE: THIS DRAWING IS SUBJECT TO CHANGE PENDING ROAD RESCUE, INC. PRODUCTION ENGINEERING APPROVAL. © ROAD RESCUE, INC. ALL RIGHTS RESERVED.

# 70" HEADROOM, 46 INCH AISLE F-450 ULTRAMEDIC WALK-THROUGH

DEALER SIGNATURE

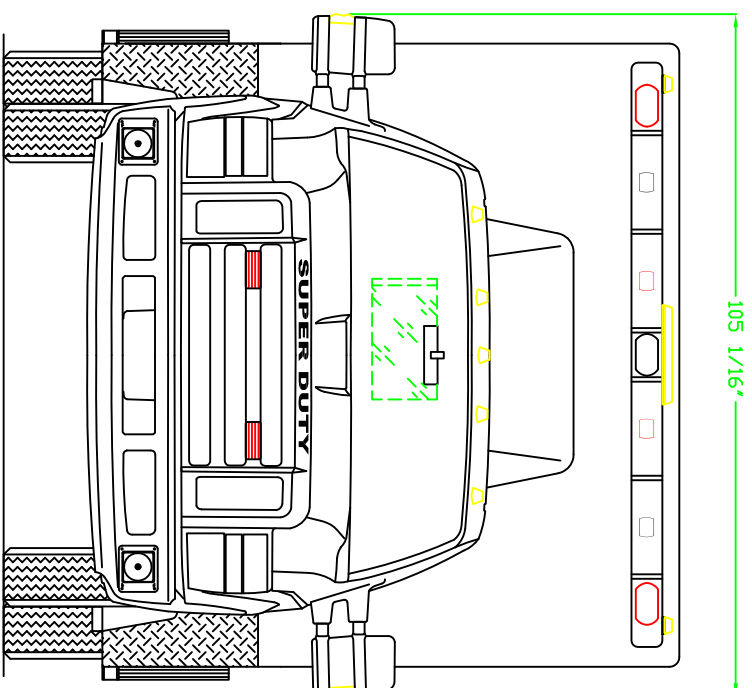
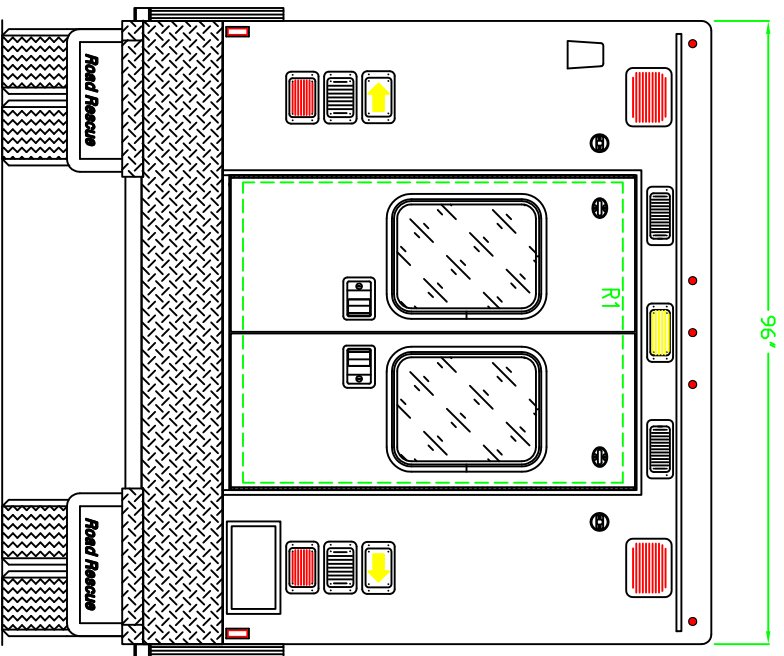

DOOR NO.	CLEAR OPENING HEIGHT	WIDTH	NOTES
R1	59.00"	49.00"	FIXED TINTED WINDOWS 18" X 24"

NOTES:

NOTES:

DETAILS ARE CONCEPTUAL ONLY. LAYOUT AND ALL DIMENSIONS ARE APPROXIMATE AND SUBJECT TO MODIFICATION BY DESIGN ENGINEERING.

**Road Rescue, Inc.** 2914 SPARTAN PLACE  
P.O. BOX 1178  
MARION, SC 29571

**FRONT & REAR EXTERIOR DETAIL**

BID NUMBER

www.roadrescue.com PHONE 843-676-2900  
DRAWN BY DATE 9/1/07 REVISION 1

REVISION 2 REVISION 3 SCALE NONE SHEET 3 OF 9



NOTE: THIS DRAWING IS SUBJECT TO CHANGE PENDING ROAD RESCUE, INC. PRODUCTION ENGINEERING APPROVAL. ©ROAD RESCUE, INC. ALL RIGHTS RESERVED.

# 70" HEADROOM, 46 INCH AISLE F-450 ULTRAMEDIC WALK-THROUGH

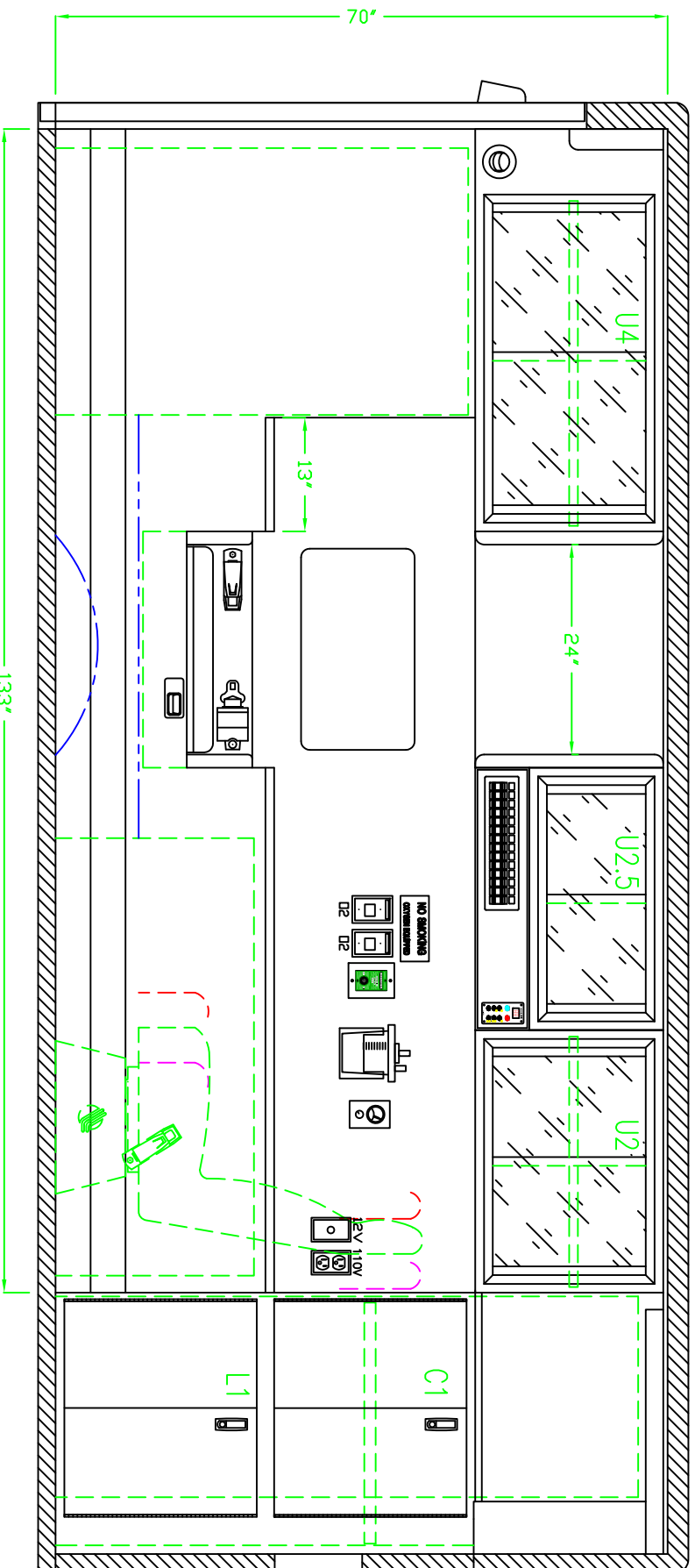

DOOR NO.	INTERIOR DIMENSIONS			NOTES	DOOR NO.	INTERIOR DIMENSIONS			MISC. NOTES
	HEIGHT	WIDTH	DEPTH			HEIGHT	WIDTH	DEPTH	
C1	23.00"	28.50"	15.50"	DOUBLE ALUM. LOCKING DOOR, (1) ADJ. SHELF	U4	21.50"	38.00"	17.00"	SLIDING PLEX DOORS, (1) ADJ. SHELF, RESTOCK
L1	23.50"	28.50"	15.50"	DOUBLE ALUM. NON-LOCKING DOOR,					
U2	21.50"	29.50"	17.00"	SLIDING PLEX DOORS, (1) ADJ. SHELF, RESTOCK					
U2.5	15.00"	29.50"	17.00"	SLIDING PLEX DOORS, RESTOCK					

DETAILS ARE CONCEPTUAL ONLY. LAYOUT AND ALL DIMENSIONS ARE APPROXIMATE AND SUBJECT TO MODIFICATION BY DESIGN ENGINEERING.

**Road Rescue, Inc.** 2914 SPARTAN PLACE  
P.O. BOX 1178  
MARION, SC 29571  
www.roadrescue.com PHONE 843-676-2900 FAX 843-676-2997

**STREETSIDE INTERIOR DETAIL**

REVISION 2 REVISION 3 REVISION 4

DATE 9/1/07

SCALE NONE

SHEET 4 OF 9

BID NUMBER

**BASE**

NOTE: THIS DRAWING IS SUBJECT TO CHANGE PENDING ROAD RESCUE, INC. PRODUCTION ENGINEERING APPROVAL. © ROAD RESCUE, INC. ALL RIGHTS RESERVED.

# 70" HEADROOM, 46 INCH AISLE F-450 ULTRAMEDIC WALK-THROUGH

DEALER SIGNATURE

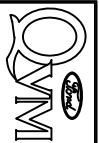
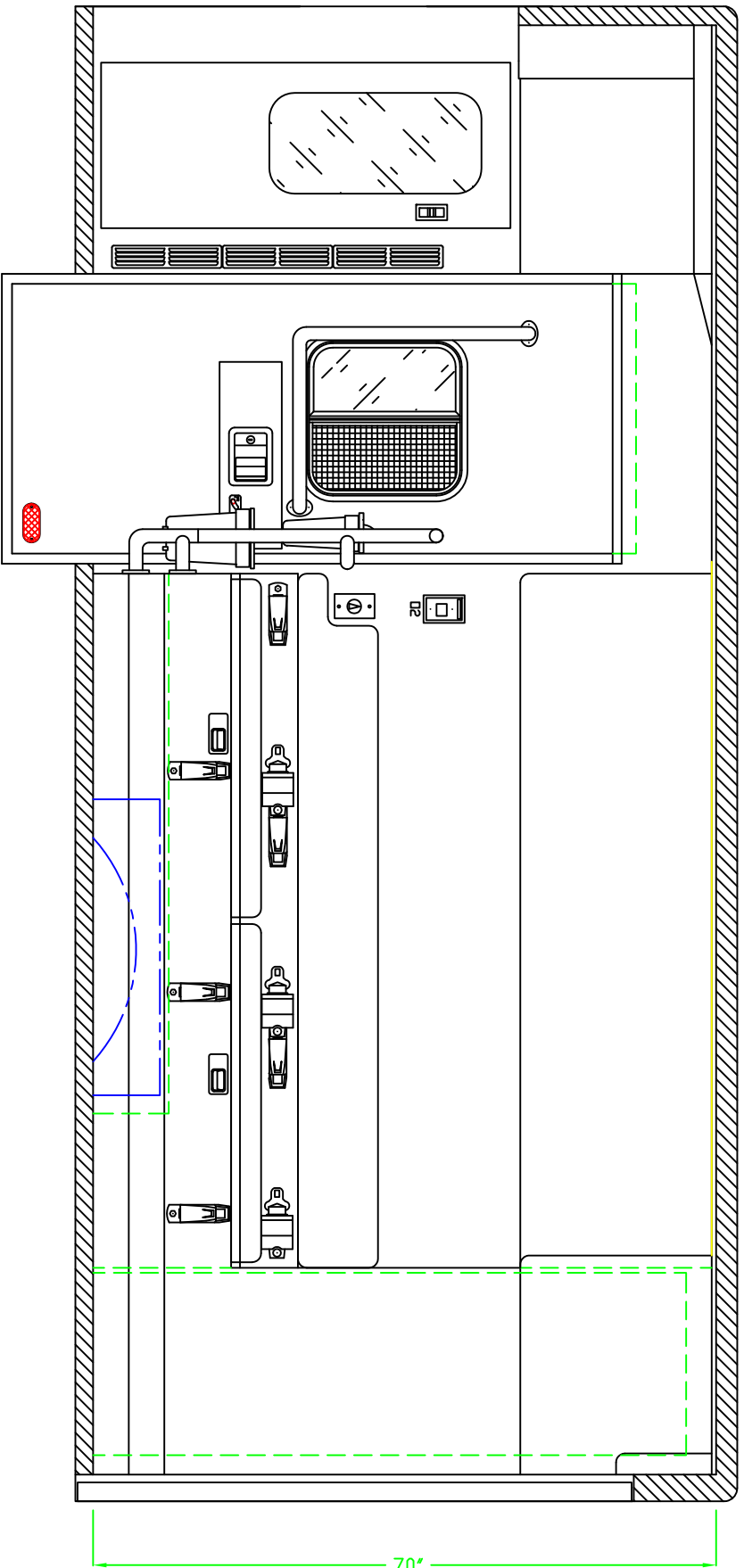
NOTES:

DETAILS ARE CONCEPTUAL ONLY. LAYOUT AND ALL DIMENSIONS ARE APPROXIMATE AND SUBJECT TO MODIFICATION BY DESIGN ENGINEERING.

**Road Rescue, Inc.** 2914 SPARTAN PLACE  
P.O. BOX 1178  
MARION, SC 29571  
www.roadrescue.com PHONE 843-676-2900 FAX 843-676-2997

## CURBSIDE INTERIOR DETAIL

BID NUMBER

DRAWN BY DATE REVISION 1

9/1/07

REVISION 2

REVISION 3

SCALE

NONE

SHEET 5 OF 9



NOTE: THIS DRAWING IS SUBJECT TO CHANGE PENDING ROAD RESCUE, INC. PRODUCTION ENGINEERING APPROVAL. © ROAD RESCUE, INC. ALL RIGHTS RESERVED.

# 70" HEADROOM, 46 INCH AISLE F-450 ULTRAMEDIC WALK-THROUGH

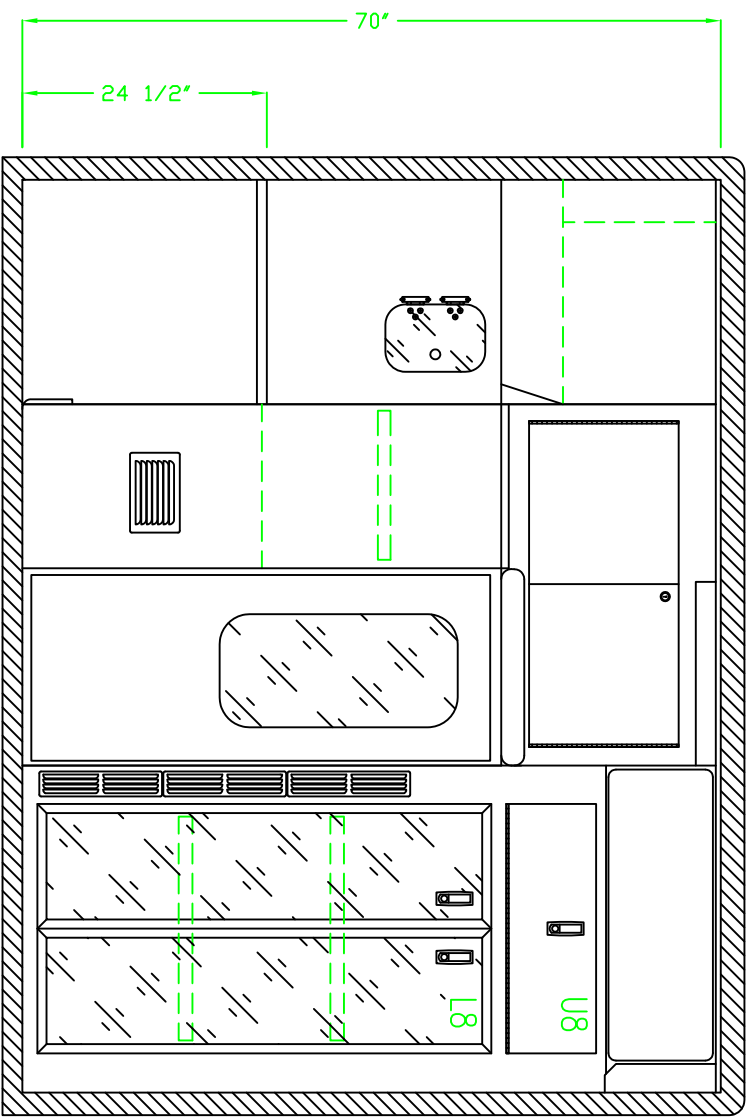

INTERIOR DIMENSIONS			NOTES
DOOR NO.	HEIGHT	WIDTH	
U8	9.00"	25.00"	SINGLE ALUM. DOOR, LOCKING LATCH
L8	48.00"	28.00"	DOUBLE PLEX DOORS, (2) ADJ. SHELVES

NOTES:  
 DETAILS ARE CONCEPTUAL ONLY. LAYOUT AND ALL DIMENSIONS ARE APPROXIMATE AND SUBJECT TO MODIFICATION BY DESIGN ENGINEERING.

**Road Rescue, Inc.** 2914 SPARTAN PLACE  
 P.O. BOX 1178  
 MARION, SC 29571  
 www.roadrescue.com PHONE 843-676-2900 FAX 843-676-2997

**FRONT INTERIOR DETAIL**

REVISION 1    REVISION 2    REVISION 3    SCALE NONE    SHEET 6 OF 9

BID NUMBER **BASE**

NOTE: THIS DRAWING IS SUBJECT TO CHANGE PENDING ROAD RESCUE, INC. PRODUCTION ENGINEERING APPROVAL. © ROAD RESCUE, INC. ALL RIGHTS RESERVED.



In Service for Life<sup>SM</sup>

DEALER SIGNATURE



# 70" HEADROOM, 46 INCH AISLE F-450 ULTRAMEDIC WALK-THROUGH

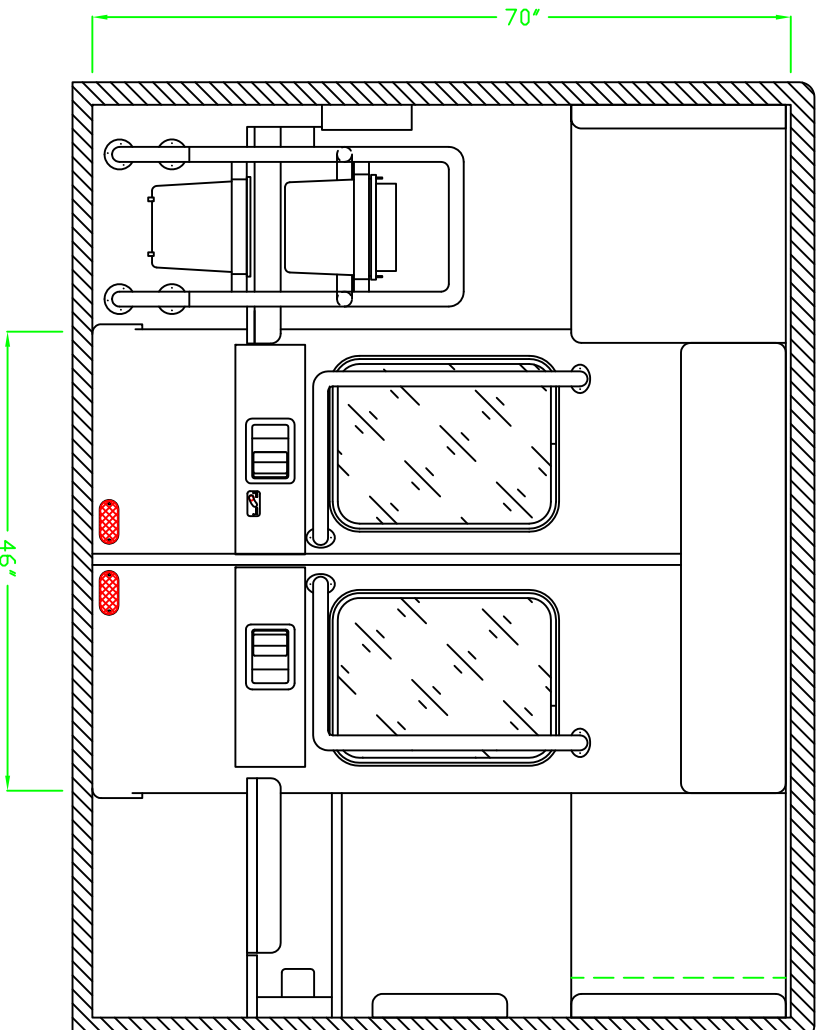

NOTES:

NOTES:

DETAILS ARE CONCEPTUAL ONLY. LAYOUT AND ALL DIMENSIONS ARE APPROXIMATE AND SUBJECT TO MODIFICATION BY DESIGN ENGINEERING.

**Road Rescue, Inc.** 2914 SPARTAN PLACE  
P.O. BOX 1178  
MARION, SC 29571

www.roadrescue.com PHONE 843-676-2900 FAX 843-676-2997

## REAR INTERIOR DETAIL

BID NUMBER

DRAWN BY

DATE

9/1/07

REVISION 1

REVISION 2

REVISION 3

SCALE

NONE

SHEET 7 OF 9



NOTE: THIS DRAWING IS SUBJECT TO CHANGE PENDING ROAD RESCUE, INC. PRODUCTION ENGINEERING APPROVAL. © ROAD RESCUE, INC. ALL RIGHTS RESERVED.

# 70" HEADROOM, 46 INCH AISLE F-450 ULTRAMEDIC WALK-THROUGH

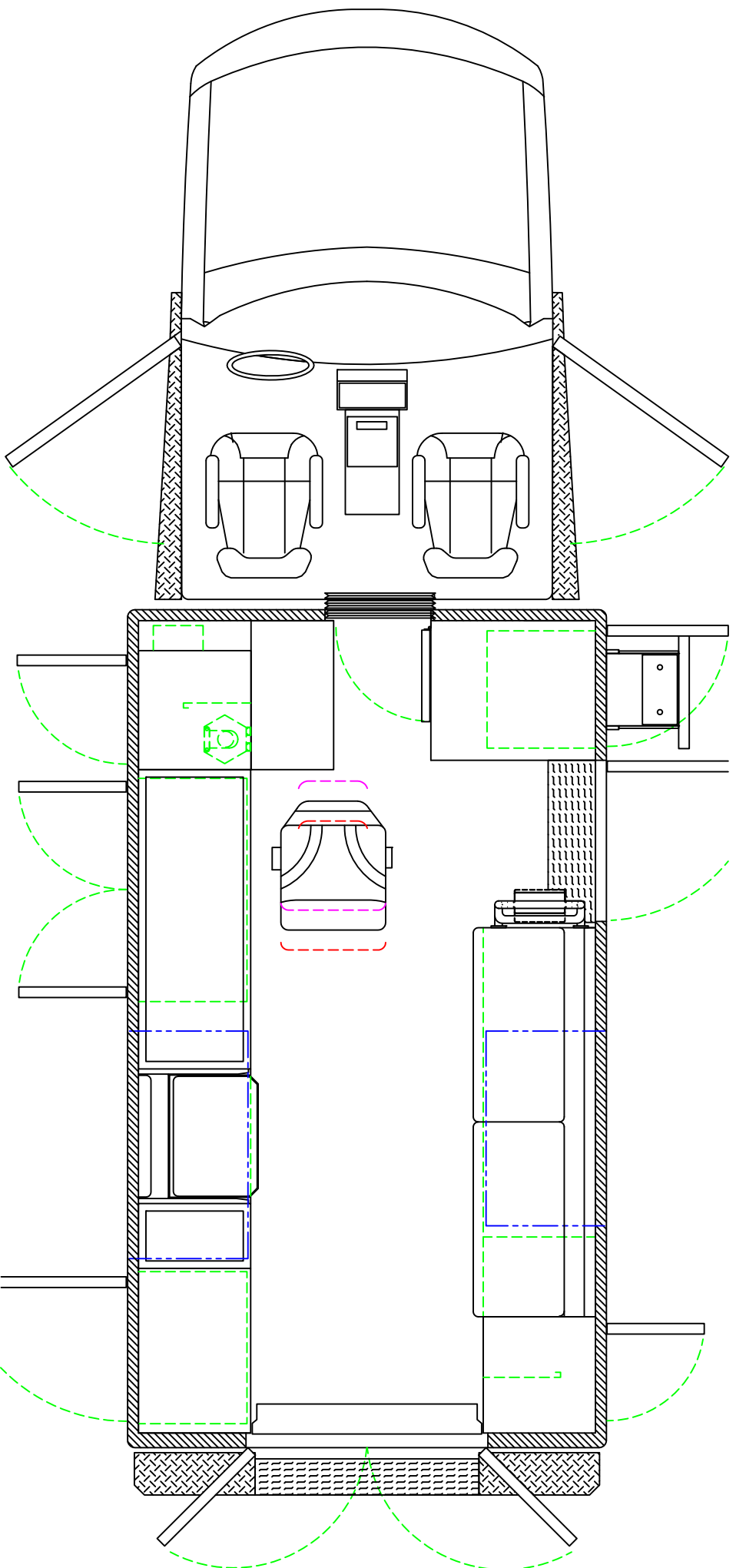

NOTES:

NOTES:

DETAILS ARE CONCEPTUAL ONLY.  
LAYOUT AND ALL DIMENSIONS ARE APPROXIMATE AND  
SUBJECT TO MODIFICATION BY DESIGN ENGINEERING.

<b>Road Rescue, Inc.</b> <small>2914 SPARTAN PLACE          P.O. BOX 1178          MARION, SC 29571          www.roadrescue.com PHONE 843-676-2900 FAX 843-676-2997</small>		<b>OVERHEAD FLOOR DETAIL</b>		BID NUMBER	
DRAWN BY DATE 9/1/07	REVISION 1	REVISION 2	REVISION 3	SCALE NONE	SHEET 8 OF 9
NOTE: THIS DRAWING IS SUBJECT TO CHANGE PENDING ROAD RESCUE, INC. PRODUCTION ENGINEERING APPROVAL. © ROAD RESCUE, INC. ALL RIGHTS RESERVED.					





In Service for Life<sup>SM</sup>

# 70" HEADROOM, 46 INCH AISLE F-450 ULTRAMEDIC WALK-THROUGH

DEALER SIGNATURE

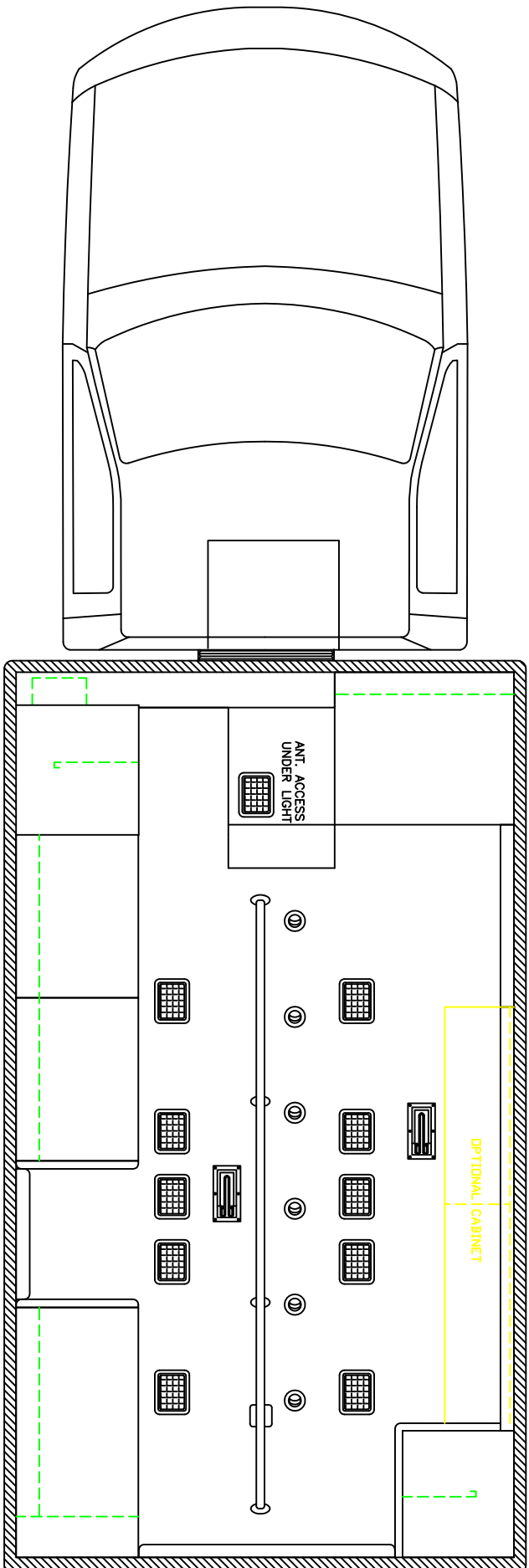

NOTES:

NOTES:

DETAILS ARE CONCEPTUAL ONLY.  
LAYOUT AND ALL DIMENSIONS ARE APPROXIMATE AND  
SUBJECT TO MODIFICATION BY DESIGN ENGINEERING.

**Road Rescue, Inc.** 2914 SPARTAN PLACE  
P.O. BOX 1178  
MARION, SC 29571  
www.roadrescue.com PHONE 843-676-2900 FAX 843-676-2997

## OVERHEAD CEILING DETAIL

BID NUMBER

DRAWN BY DATE 9/1/07 REVISION 1

REVISION 2

REVISION 3

SCALE NONE

SHEET 9 OF 9



NOTE: THIS DRAWING IS SUBJECT TO CHANGE PENDING ROAD RESCUE, INC. PRODUCTION ENGINEERING APPROVAL. © ROAD RESCUE, INC. ALL RIGHTS RESERVED.